

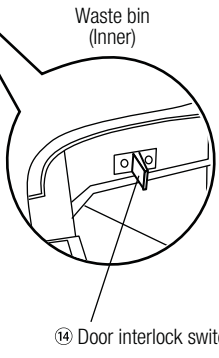

Shredmaster 31SX/33SM/35SX Instruction Manual

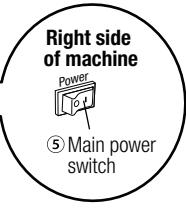

Indicator		Switch panel	
⑨ Power ON			⑦ Manual forward button
⑩ Door open			⑥ Power ON/OFF button
⑪ Bin-full			⑧ Manual reverse button
⑫ Cool down			
⑬ Paper jam			

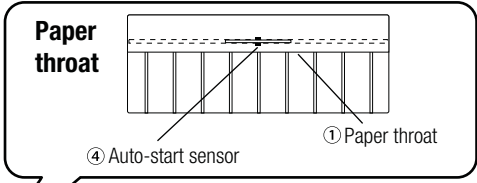
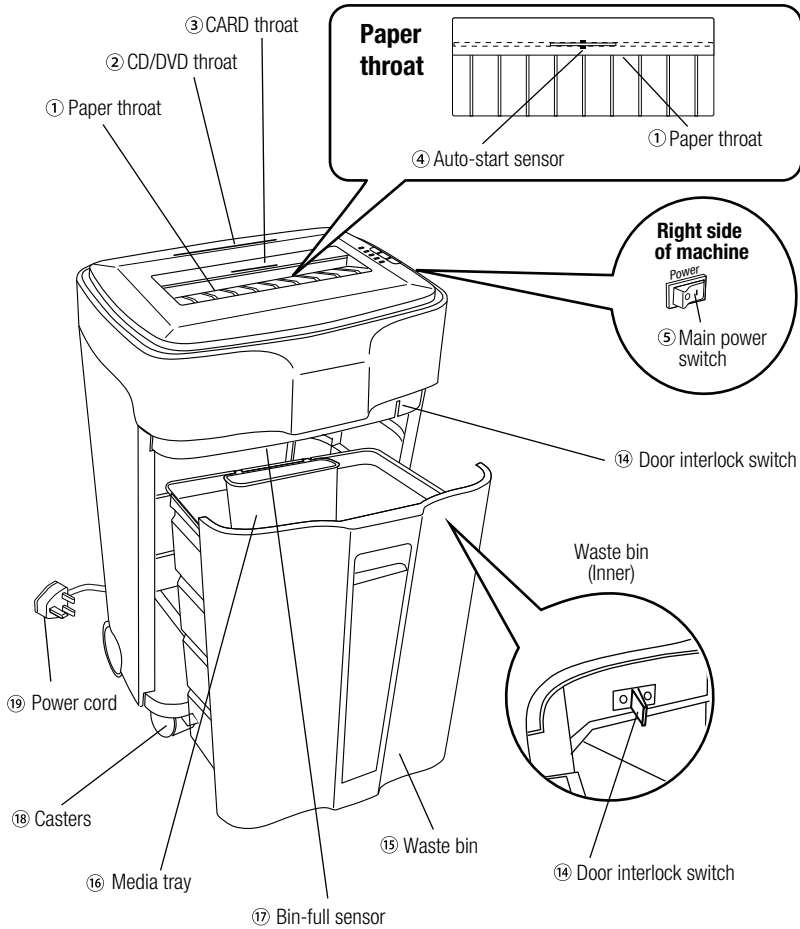

Specifications

	GBC Shredmaster 31SX	GBC Shredmaster 33SM	GBC Shredmaster 35SX
Cutting Type	Confetti Cut (Paper)	Micro Cut (Paper)	Confetti Cut (Paper)
Shred Size	4 x 25 mm (Paper)	2 x 10 mm (Paper)	4 x 25 mm (Paper)
Security Class	DIN S3	DIN S4	DIN S3
Sheet Capacity (one pass) ※ Sheet capacity varies depending on the paper quality and humidity. Specs are established based on leading paper brand.※	Paper: 14 sheets (80 gsm) 16 sheets (70 gsm) Media: 1 pc (CD/DVD/Card)	Paper: 8 sheets (80 gsm) 10 sheets (70 gsm) Media: 1 pc (CD/DVD/Card)	Paper: 19 sheets (80 gsm) 21 sheets (70 gsm) Media: 1 pc (CD/DVD/Card)
Speed	2.0 m/min (Paper)	2.2 m/min (Paper)	2.7 m/min (Paper)
Entry Width	228 mm (Paper)		230 mm (Paper)
Product Dimensions	H600mm x W372 x D322mm		H667mm x W404 x D350mm
Bin Capacity	30 litres		36 litres
Weight	12.5 Kg		19.0 Kg
Rated Voltage/Frequency	230V / 50Hz		230V / 50Hz
Rated Current	2.0 Amps		4.0 Amps
Duty Cycle	11 mins ON / 90 minutes OFF	15 mins ON / 90 minutes OFF	15 mins ON / 90 minutes OFF

Introduction

Thank you for choosing this shredder from GBC. We are sure it will serve you well, but please take a little time to read these instructions to ensure you get the best out of your machine.

Safety First



- Please store this instruction manual in a safe place for future reference.
- Please pay close attention to the safety symbols on the top of the shredder and operate the machine accordingly.
- If the shredder needs cleaning, unplug the unit from the power socket and use a damp cloth. NB. Do not use any cleaning products to clean the unit.
- Do not position the unit near to an object that radiates heat.
- Do not place the unit in a damp environment.
- Take care not to splash any liquid onto the machine.
- Return the product and proof of purchase with receipt to the store at which it was purchased if...
 - The power cable or plug is broken.
 - The machine malfunctions because liquid was accidentally spilt onto the machine.
 - The shredder doesn't operate despite following the guidelines in the manual.
- Make sure the power cable isn't a trip hazard.
- To avoid risk of injury, do not open the machine's casing to attempt DIY repair. Any attempted repair by an unqualified person will invalidate the warranty.



KEEP OUT OF REACH OF CHILDREN.

Warning Symbols and Indicators



Safety First



This means you should be careful because long hair can become entangled in the cutting head.



This means don't reach into the feed opening of the cutting head.



This means be careful of ties and other loose clothing which could become entangled in the cutting head.



This means keep children away from shredder.



This means no aerosols.



This means don't tilt or topple the shredder.



Bin Door Open indicator (Red)

– This means the bin door is open.



Bin Full indicator (Red)

– This means the bin is full.



Cool Down indicator (Red)

This means the machine is cooling down.



Paper jam indicator (Red)

This means there is a paper jam.

Preparation before use

How to use the shredder correctly:

- 1 Take care not to insert fingers, ties or other objects into the entry slot of the shredder.
- 2 We recommend to remove staples and paperclips, avoid laminating materials, plastic bags etc. from being passed through the shredder. This will prevent damage to the cutters.
- 3 Do not shred wet paper as it can tangle in the cutters.
- 4 Do not shred more than the stated sheet capacity in one pass.

Operation

- 1 Connect shredder to mains supply.
- 2 Check that the ON/OFF switch(5) at the right side of the machine is switched to the 'ON' position.
- 3 To commence shredding, press the power button(6). This will illuminate the blue symbol () on the power button, which sets the shredder into auto mode. You are now ready to shred. Insert paper to be shredded into the paper throat(1). The shredder will detect the paper and start automatically.

CD and Credit Card Shredding:

A separate media tray(16) is provided to collect the shredded CD and credit cards shards. Ensure that this is correctly mounted onto the waste bin before shredding.

1. Credit Card: Insert the magnetic strip side of the card horizontally into the card throat(3).
2. CD/DVD: Insert CD into the CD/DVD throat(2).

Note: Only shred 1 credit card or 1 CD at a time. Empty the media tray after each use to avoid waste spilling over into the paper waste bin.

After shredding, press the power button(6) to OFF power and switch the main power switch(5) at the right side of the machine to the 'OFF' position.

- 4

Note: To protect the motor, papers and CD or credit cards cannot be shredded simultaneously. For paper shredding, the paper width should not exceed the width of the paper throat.

Door Open Safety Function

As a safety precaution, if the bin is pull out during shredding, the shredder will stop and the door open indicator will illuminate (). **Note: Please ensure that the bin is fitted properly so that the interlock switch is triggered. In the event that the bin is not closed properly, the machine will not be able to start shredding.**

Over Heating

If this product is used continuously for a long period of time the shredder may overheat. To protect the motor, the shredder will automatically cut off and the cool down indicator () will illuminate. Please allow it to cool down before resuming use.

Bin Full

The shredder will not function when the bin is full and the bin full indicator () will illuminate. Please empty the bin.



- 1 Pull open the bin slowly to empty.
- 2 Push the empty bin back into place and press the auto button to resume shredding.

Note: Over filling the bin may cause paper jam. Empty the bin regularly to avoid paper spilling over or difficulty in removing the bin when it is too full.

Reverse Function

- 1 Should you wish to reverse the shredding direction whilst shredding a document, a reverse button(8) has been fitted for your convenience.
- 2 By pressing the reverse button(8) the shredding cutters will change direction allowing the retrieval of the document being shredded.
- 3 The reverse function will only run whilst the button is being pressed. When the reverse button(8) has been released the shredder will revert to Auto mode.

Rare Occasions of Jamming

In the unlikely event of the shredder jamming, the paper jam indicator () will illuminate. Shredder will stop shredding and automatically reverse to clear paper jam. If paper jam cannot be resolved by auto jam clearance, try clearing the jam using the reverse () and forward () function to unblock the feed area. Do not do this too quickly as this can damage the shredder.

WARNING - Do not under any circumstances use any metal objects (scissors, letter openers etc.) in an attempt to clear the jam as this may cause serious injury.

Lubrication of the Shredder

Only use Rexel Oil Sheets (2101948) to lubricate. ACCO Brands accepts no liability for product performance or safety when other types or brands of lubricants are used on any part(s) of this machine.

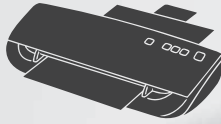

GBC Laminating / Plastifieuses / Laminiergeräte



Rexel Shredding / Destructeurs / Aktenvernichter



GBC Binding / Perforelieuses / Bindegeräte

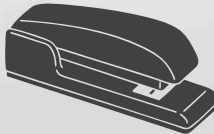

Rexel Stapling / Agrafage / Heftgeräte